





CONTENTS

ABOUT US

DOORSTATIONS

INTERCOM SYSTEMS

VIDEO INTERCOM SYSTEMS

MAILBOXES

KIT MONITORS

SIGNAGE

CONTACT



 ABOUT US

CTC, with over 30 years of experience, represents the highest quality standards and excellent service in the field of building communication.

We develop and manufacture high-quality doorstations and video intercom systems, security systems and signage.

Our particular strength lies in manufacturing customized solutions that are constantly adapted to new market conditions and the needs of our customers.

CTC is certified according to DIN EN ISO 9001:2015, which is the most widely recognized and significant quality management standard nationally and internationally.

All our products bear the CE mark and comply with EU-wide requirements for safety, health, and environmental protection.

We are a team of professionals who love what they do.

Quality with expertise, vision, and character.



PRESTIGE VENUS AUDIO

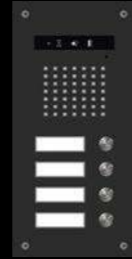

A 2-wire audio door intercom system that combines classic and timeless design with state-of-the-art technology.

The luxurious and durable materials used in the Prestige brass door intercom systems add a unique touch to building entrances.

- Compact design for reliable and long-term use
- Optional: Buttons with specially shaped name engravings or illuminated frames
- Durable construction made of brass or v in a wide range of RAL colours
- Shallow installation housing for easy installation
- Versatile options such as access control systems, street and number engravings, and lighting
- Covers up to 4 entrances

Wiring system: 2-wire system

Colours: Stainless steel or gold stainless steel

Aluminium colours: White, Silver, Anthracite, Champagne, Cypress Green

Dimensions:

- Standard sizes as in the dimension catalog
- Available in any desired size (additional cost)
- Integrable in custom-made solutions

PRESTIGE VENUS VIDEO



Timeless design meets advanced technology.

The luxurious and durable materials of the Prestige brass door intercom system add an artistic touch to building entrances.

- Compact design for reliable and long-term use
- Optional: Buttons with specially shaped name engravings or illuminated frames
- Durable construction made of brass or Aluminium in a wide range of RAL colours
- Shallow installation housing for easy installation
- Versatile options such as access control systems, street and number engravings, and lighting
- Covers up to 4 entrances

Wiring system: 2-wire system

Colours: Stainless steel or gold stainless steel

Aluminium colours: White, Silver, Anthracite, Champagne, Cypress Green

Dimensions:

- Standard sizes as in the dimension catalog
- Available in any desired size (additional cost)
- Integrable in custom-made solutions

PRESTIGE VENUS DOME



Modern 2-wire technology combined with minimalist and noble design. The Prestige Venus Dome, especially made of brass, adds an aesthetic touch to building entrances.

- Compact design for reliable and long-term use
- Optional: Buttons with specially shaped name engravings or illuminated frames
- Durable construction made of brass or Aluminium in a wide range of RAL colours
- Shallow installation housing for easy installation
- Versatile options such as access control systems, street and number engravings, and lighting
- Covers up to 4 entrances

Wiring system: 2-wire system

Colours: Stainless steel or gold stainless steel

Aluminium colours: White, Silver, Anthracite, Champagne, Cypress Green

Dimensions:

- Standard sizes as in the dimension catalog
- Available in any desired size (additional cost)
- Integrable in custom-made solutions

ACCESS CONTROL

The protection of a building is becoming increasingly important in today's world. By implementing an efficient, modern, and technical control system that authorizes entry to your premises, you can optimize your security. Depending on your choice, you can equip your access control with a keycard, code lock, face control, or fingerprint system.

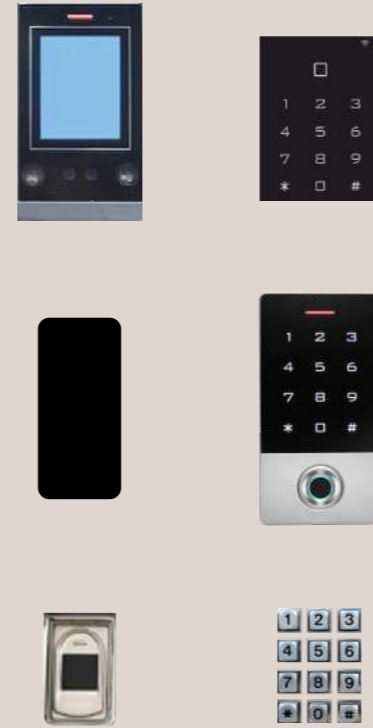



VENUS AUDIO

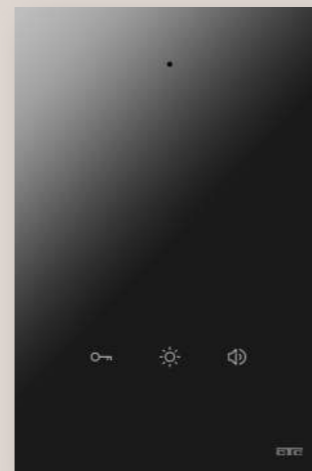

Venus Audio is an intercom system that offers an elegant design, modern technology, and easy operation as an alternative solution to conventional analog interior systems. With its many advantages and simple 2-wire installation, Venus Audio allows for easy and quick exterior wall mounting without any additional effort.

- Intercom system with hands-free functionality
- Safety glass screen
- Touch function
- Menu
- Intercommunication between devices in the same call
- Up to 4 parallel devices on each call

Wiring system: 2 wires
Colour: White, Black
Dimensions: 120x180x30mm (W/H/D)

IRIS



Reliable intercom systems with door opening function and reserve button for additional features. The range of Iris intercom systems provides complete solutions for all requirements in modern buildings. Our technological excellence based on international standards and years of experience from our employees enable us to guarantee the highest level of quality.

- Telephone-like
- Wall and table mounting
- Functions as a floor bell
- Parallel connection of up to 4 internal elements
- Also available as a replacement in the Universal 4+N series
- Combined with the Prestige door intercom system

Wiring system: 2 wires, 1+N, 4+N
Colour: White
Dimensions: 90x220x55mm (W/H/D)

VIDEO INTERCOM SYSTEMS

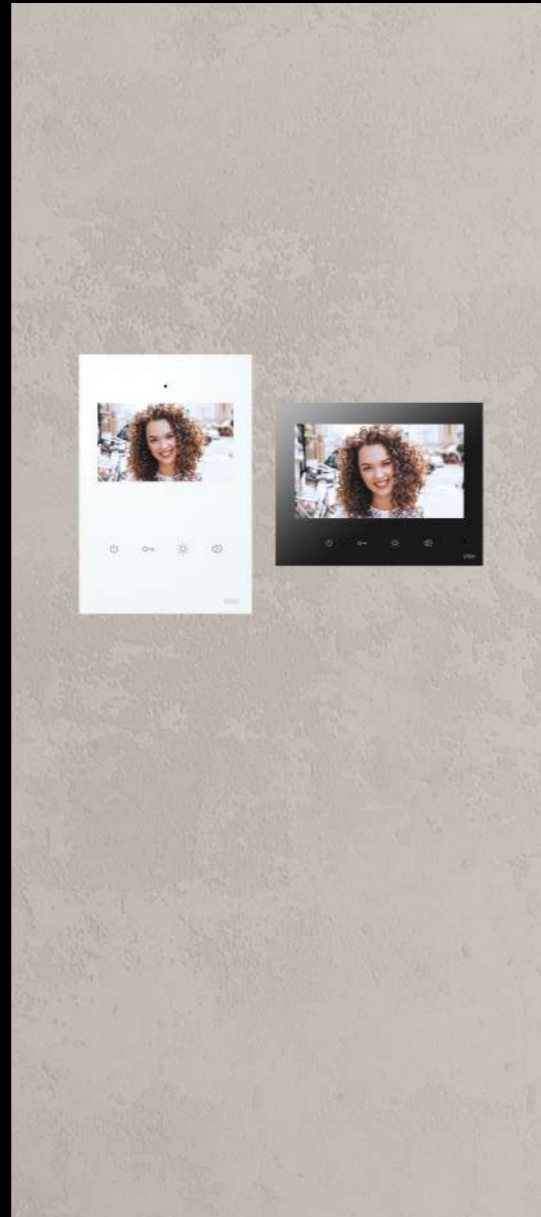

ORION VISION 4,3"

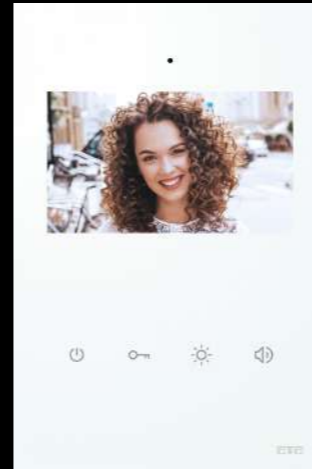

Visual entrance control is now an essential and user-friendly security feature that should not be missing in any modern building. With its dynamic design, impressive quality, and colour touchscreen, the Orion 4.3" 2-wire hands-free monitor is a reliable communication tool for your entrance area.

- 4.3" TFT colour screen
- Touch function
- High screen resolution of 480 × 480 pixels
- Intercommunication between devices in the same call
- Wall mounting
- Selection of ringtone volume or mute
- Functions as a floor bell
- Up to 4 parallel devices in each call

Wiring system: 2 wires
Colour: White, Black
Dimensions: 120x180x20mm (W/H/D)

ORION VISION 7"

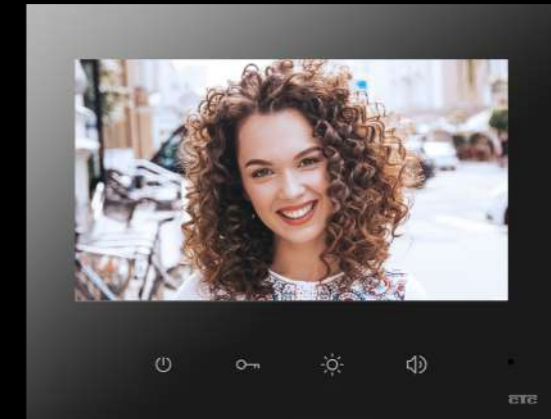

With its aesthetic design and minimalist, clean lines, the Orion Vision 7" adds elegance and sophistication to any space. High-quality materials are combined with numerous functions and advantages to create a sense of comfort and security.

- 7" TFT colour screen
- Touch function
- High-resolution screen of 800 × 480 pixels
- Intercommunication between devices in the same call
- Wall mounting
- Selection of ringtone volume or mute
- Functions as a floor bell
- Up to 4 parallel devices in each call

Wiring system: 2 wires
Colour: White, Black
Dimensions: 188x148x20mm (W/H/D)

VIDEO INTERCOM SYSTEMS

ORION VISION 7"

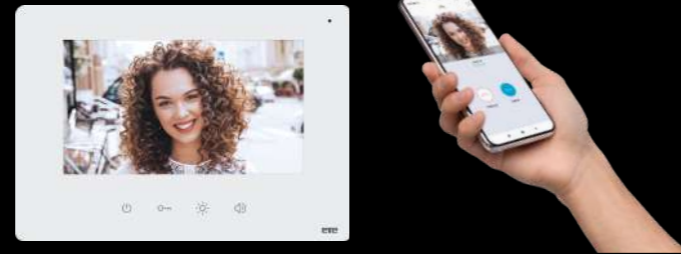

Technological efficiency for your entrance area. The new Orion 7" WiFi Monitor combines the features of the Orion 7" with additional remote control options through an associated app. It is the ideal choice for those who want to monitor their home's entrance area from anywhere.

- WiFi connection
- 7" TFT colour screen
- Touch function
- High-resolution screen of 800 x 480 pixels
- Intercommunication between devices in the same call
- Wall mounting
- Adjustable volume of the call or mute mode
- Functions as a floor bell
- Up to 4 parallel devices in each call

Wiring system: 2 wires
 Colour: White, Black
 Dimensions: 215x152x22mm (W/H/D)

KIT DOOR VISION (Non Extendable)



An innovative 2-wire system for buildings of any kind that guarantees a high level of quality of life and security.

- 7" TFT colour screen
- WiFi connection
- Touch buttons
- High-resolution screen of 800x480 pixels
- Wall mounting
- Adjustable volume of the call or mute mode
- Functions as a floor bell
- Up to 4 parallel devices in each call
- p2p cloud support for remote connection

Wiring system: 4 wires
 Monitor colour: White
 Doorstation colour: Silver
 Doorstation dimensions: 112x199x40mm (W/H/D)
 Monitor dimensions: 215x152x22mm (W/H/D)



COSTUMIZED DESIGNS

Customized designs combined with luxurious door intercom systems and a mailbox system offer an efficient all-around solution for all requirements of modern buildings.

Designed to save space and with a range of aesthetic designs, they enhance the appearance and technology of any building.

- Floor mounting
- Wall mounting
- Recessed in the door profile
- Durable materials: high-strength brass or Aluminium in a wide range of RAL colours
- Special lighting installations
- Multiple engraving and punching options such as street name and house number

Wiring system: all variants possible

Colour design: numerous colours to choose from

Dimensions: any desired size





MAILBOXES

With luxurious designs and high-quality materials, CTC creates the perfect centerpiece for any entrance area. From individual mailboxes to customized communication centers, CTC offers the right solution.



ORION VISION 4,3" DOOR VISION KIT



The 2-wire door entry kits consist of a 4.3" monitors and doorstation, covering the needs of 1 (one) to 4 (four) apartments.

DOORSTATION VIDEO KIT

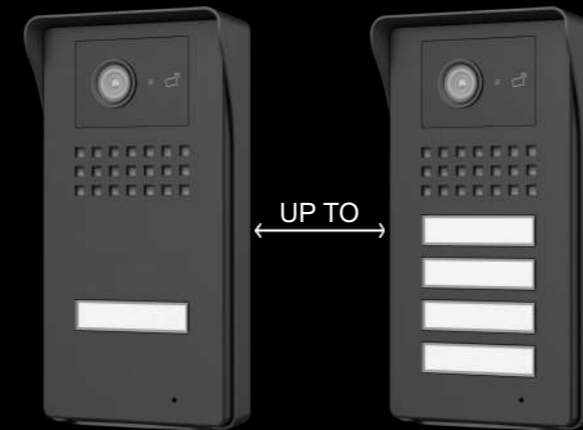

Made with durable materials and modern aesthetics, Video Kit doorstations add a unique fine line to building entrances.

- Compact construction for long life service
- Recessed, shallow box for easy installation
- Wall-mounted canopy for outdoor use
- Covering up to 4 inputs

Wiring system: 2 wires
Doorstation colour: Anodized Aluminium
Doorstation dimensions: 885x183x285mm (W/H/D)

MONITOR ORION VISION 4,3"

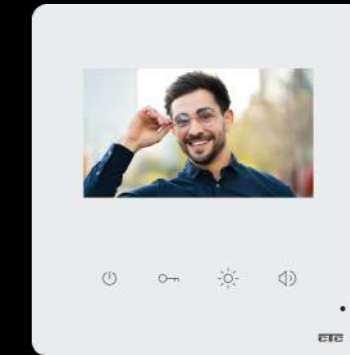

Modern design with delicate lines and quality the Orion Vision 4.3" coloured touchscreen monitor is the most reliable for your security and communication.

- 4.3" coloured TFT monitor
- Touch buttons
- High screen resolution 480x480 pixels
- Intercommunication between devices in the same call
- Wall mounting
- Works as a floor bell
- Up to 4 parallel devices in each call

Wiring system: 2 wires
Monitor colours: White, Black
Monitor dimensions: 136x143x22mm (W/H/D)

ORION VISION 7" DOOR VISION KIT



The 2-wire door entry kits consist of a 7" monitors and doorstation, covering the needs of 1 (one) to 4 (four) apartments.

DOORSTATION VIDEO KIT

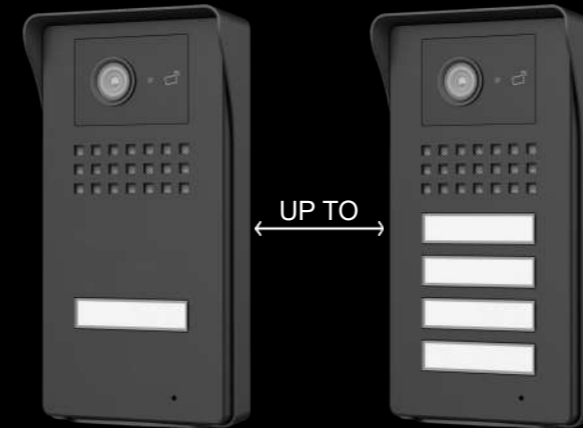

Made with durable materials and modern aesthetics, Video Kit doorstations add a unique fine line to building entrances.

- Compact construction for long life service
- Recessed, shallow box for easy installation
- Wall-mounted canopy for outdoor use
- Covering up to 4 inputs

Wiring system: 2 wires
Doorstation colour: Anodized Aluminium
Doorstation dimensions: 885x183x285mm (W/H/D)

MONITOR ORION VISION 7"

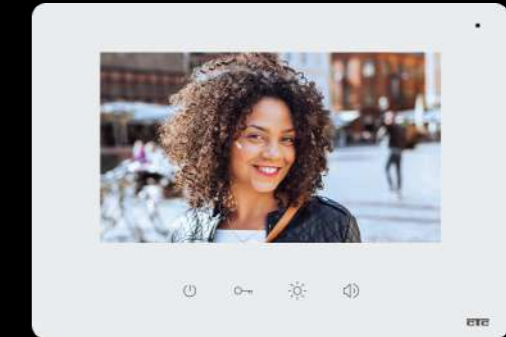

High aesthetic design with simple, clean lines that they impress and give elegance to the space. Top quality construction materials combined with multiple functions and advantages, are it's main features of video door entry Orion Vision 7" in order to create a sense of comfort and security.

- 7" coloured TFT monitor
- Touch buttons
- High screen resolution 800x480 pixels
- Intercommunication between devices in the same call
- Wall mounting
- Works as a floor bell
- Up to 4 parallel devices in each call

Wiring system: 2 wires
Monitor colours: White, Black
Monitor dimensions: 215x152x22mm (W/H/D)

"An integral part of any modern building, which emphasizes corporate design and contributes to guest satisfaction."



DESIGN

Good signage helps with direct orientation, smoother operation, and efficient organization. It is crucial for the perception of a place. Aesthetics, maximum functionality, and quality are the focus of CTC in planning, design, and construction. The signage design service offered by our company provides outstanding results that will impress your visitors.

Our designers create a realistic image of the chosen signage during the development process. Then our factory begins manufacturing your luxurious and distinctive signage using the most advanced cutting and processing machines (CNC laser, router, electrostatic painting, etc.).

Categories of signage:

- Hotels
- Shops/Offices
- Buildings of any kind

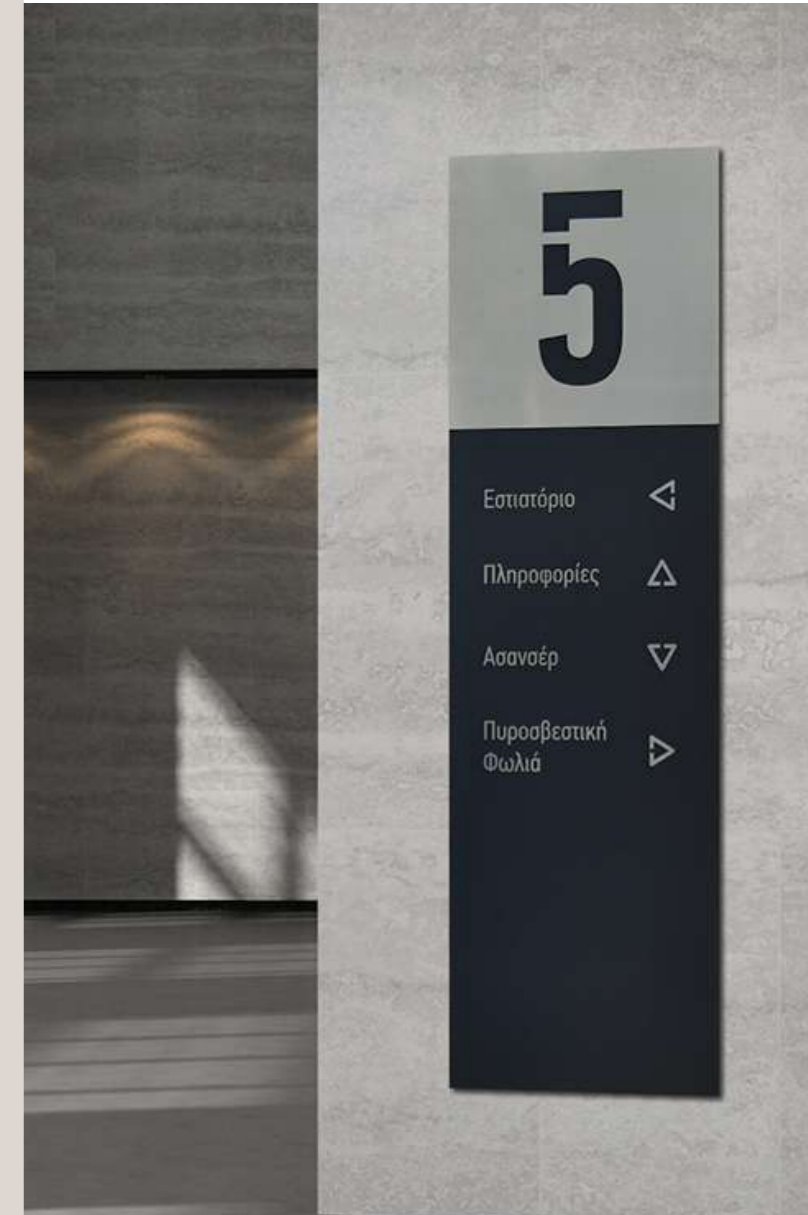

PRODUCT PRICE LIST

June 2024

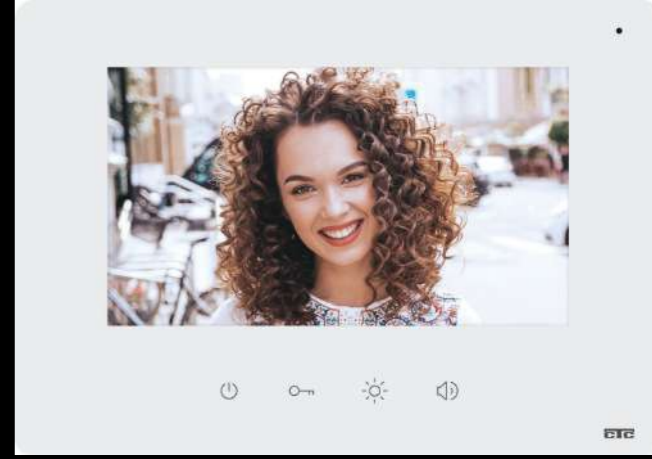

Audio doorstation system Prestige Venus Audio Aluminium 2K

APT.	TYPE	CODE	PRICE €	NGV 300	VT 12	TOTAL €
1	ALSTAR/A-1	45101*	214,00	1	1	351,00
2	ALSTAR/A-2	45102*	232,00	1	1	369,00
3	ALSTAR/A-3	45103*	250,00	1	1	387,00
4	ALSTAR/A-4	45104*	268,00	1	1	405,00
5	ALSTAR/A-5	45105*	286,00	1	1	423,00
6	ALSTAR/A-6	45106*	304,00	1	1	441,00
7	ALSTAR/A-7	45107*	322,00	1	1	459,00
8	ALSTAR/A-8	45108*	340,00	1	1	477,00
9	ALSTAR/A-9	45109*	358,00	1	1	495,00
10	ALSTAR/A-10	45110*	376,00	1	1	513,00
11	ALSTAR/A-11	45111*	394,00	1	1	531,00
12	ALSTAR/A-12	45112*	412,00	1	1	549,00
13	ALSTAR/A-13	45113*	430,00	1	1	567,00
14	ALSTAR/A-14	45114*	448,00	1	1	585,00
15	ALSTAR/A-15	45115*	466,00	1	1	603,00
16	ALSTAR/A-16	45116*	484,00	1	1	621,00
17	ALSTAR/A-17	45117*	502,00	1	1	639,00
18	ALSTAR/A-18	45118*	520,00	1	1	657,00
19	ALSTAR/A-19	45119*	538,00	1	1	675,00
20	ALSTAR/A-20	45120*	556,00	1	1	693,00

For additional entrances, select the doorstation of your choice and add a brancher:

016050	016009
95,00 €	42,00 €

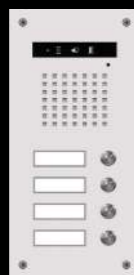

Prestige Aluminium



APT.	TYPE	CODE	PRICE €	NGV 300	VT 12	TOTAL €
1	INSTAR/A-1	451015	235,00	1	1	372,00
2	INSTAR/A-2	451025	254,00	1	1	391,00
3	INSTAR/A-3	451035	273,00	1	1	410,00
4	INSTAR/A-4	451045	292,00	1	1	429,00
5	INSTAR/A-5	451055	311,00	1	1	448,00
6	INSTAR/A-6	451065	330,00	1	1	467,00
7	INSTAR/A-7	451075	349,00	1	1	486,00
8	INSTAR/A-8	451085	368,00	1	1	505,00
9	INSTAR/A-9	451095	387,00	1	1	524,00
10	INSTAR/A-10	451105	406,00	1	1	543,00
11	INSTAR/A-11	451115	425,00	1	1	562,00
12	INSTAR/A-12	451125	444,00	1	1	581,00
13	INSTAR/A-13	451135	463,00	1	1	600,00
14	INSTAR/A-14	451145	482,00	1	1	619,00
15	INSTAR/A-15	451155	501,00	1	1	638,00
16	INSTAR/A-16	451165	520,00	1	1	657,00
17	INSTAR/A-17	451175	539,00	1	1	676,00
18	INSTAR/A-18	451185	558,00	1	1	695,00
19	INSTAR/A-19	451195	577,00	1	1	714,00
20	INSTAR/A-20	451205	596,00	1	1	733,00

For additional entrances, select the doorstation of your choice and add a brancher:

016050	016009
95,00 €	42,00 €

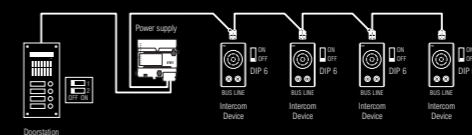

Audio doorstation system Prestige Venus Audio Stainless Steel

Housing	1-2 Apartments	3-4 Apartments	5-6 Apartments	7 Apartments	8-10 Apartments	11-16 Apartments	17-22 Apartments
AL	62001* - 48,00€	62012* - 60,50€	62003* - 63,00€	62013* - 69,50€	62004* - 76,00€	62023* - 79,80€	62024* - 110,00€

Housing	1-2 Apartments	3-4 Apartments	5-6 Apartments	7 Apartments	8-10 Apartments	11-16 Apartments	17-22 Apartments
IN	620015 - 63,00€	620125 - 68,50€	620035 - 72,00€	620135 - 86,00€	620045 - 91,00€	620235 - 100,00€	620245 - 119,00€

Video doorstation system 2K Prestige Venus Dome Aluminium

APT.	TYPE	CODE	PRICE €	NGV 300	BTU 2K	VT 12	TOTAL €
1	ALSTAR/V-1	45301*	338,00	1	-	1	475,00
2	ALSTAR/V-2	45302*	356,00	1	1	1	541,00
3	ALSTAR/V-3	45303*	374,00	1	1	1	559,00
4	ALSTAR/V-4	45304*	392,00	1	1	1	577,00
5	ALSTAR/V-5	45305*	410,00	1	2	1	643,00
6	ALSTAR/V-6	45306*	428,00	1	2	1	661,00
7	ALSTAR/V-7	45307*	446,00	1	2	1	679,00
8	ALSTAR/V-8	45308*	464,00	1	2	1	697,00
9	ALSTAR/V-9	45309*	482,00	1	3	1	763,00
10	ALSTAR/V-10	45310*	500,00	1	3	1	781,00
11	ALSTAR/V-11	45311*	518,00	1	3	1	799,00
12	ALSTAR/V-12	45312*	536,00	1	3	1	817,00
13	ALSTAR/V-13	45313*	554,00	1	4	1	883,00
14	ALSTAR/V-14	45314*	572,00	1	4	1	901,00
15	ALSTAR/V-15	45315*	590,00	1	4	1	919,00
16	ALSTAR/V-16	45316*	608,00	1	4	1	937,00
17	ALSTAR/V-17	45317*	626,00	1	5	1	1003,00
18	ALSTAR/V-18	45318*	644,00	1	5	1	1021,00
19	ALSTAR/V-19	45319*	662,00	1	5	1	1039,00
20	ALSTAR/V-20	45320*	680,00	1	5	1	1057,00

For additional entrances, select the doorstation of your choice and add a brancher:

016050	016051	016009
95,00 €	48,00 €	42,00 €



Prestige Aluminium



APT.	TYPE	CODE	PRICE €	NGV 300	BTU 2K	VT 12	TOTAL €
1	INSTAR/V-1	453015	365,00	1	-	1	502,00
2	INSTAR/V-2	453025	384,00	1	1	1	569,00
3	INSTAR/V-3	453035	403,00	1	1	1	588,00
4	INSTAR/V-4	453045	422,00	1	1	1	607,00
5	INSTAR/V-5	453055	441,00	1	2	1	674,00
6	INSTAR/V-6	453065	460,00	1	2	1	693,00
7	INSTAR/V-7	453075	479,00	1	2	1	712,00
8	INSTAR/V-8	453085	498,00	1	2	1	731,00
9	INSTAR/V-9	453095	517,00	1	3	1	798,00
10	INSTAR/V-10	453105	536,00	1	3	1	817,00
11	INSTAR/V-11	453115	555,00	1	3	1	836,00
12	INSTAR/V-12	453125	574,00	1	3	1	855,00
13	INSTAR/V-13	453135	593,00	1	4	1	922,00
14	INSTAR/V-14	453145	612,00	1	4	1	941,00
15	INSTAR/V-15	453155	631,00	1	4	1	960,00
16	INSTAR/V-16	453165	650,00	1	4	1	979,00
17	INSTAR/V-17	453175	669,00	1	5	1	1046,00
18	INSTAR/V-18	453185	688,00	1	5	1	1065,00
19	INSTAR/V-19	453195	707,00	1	5	1	1084,00
20	INSTAR/V-20	453205	726,00	1	5	1	1103,00

For additional entrances, select the doorstation of your choice and add a brancher:

016050	016051	016009
95,00 €	48,00 €	42,00 €

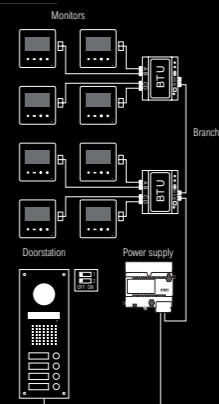

Video doorstation system 2K Prestige Venus Dome Stainless Steel

Housing	1 Apartment	2-3 Apartments	4 Apartments	5-7 Apartments	8-12 Apartments	13-19 Apartments	20 Apartments
AL	62012* - 60,50€	62003* - 63,00€	62013* - 69,50€	62004* - 76,00€	62023* - 79,80€	62024* - 110,00€	62025* - 120,00€

Housing	1 Apartment	2-3 Apartments	4 Apartments	5-7 Apartments	8-12 Apartments	13-19 Apartments	20 Apartments
IN	620125 - 68,50€	620035 - 72,00€	620135 - 86,00€	620045 - 91,00€	620235 - 100,00€	620245 - 119,00€	620255 - 130,00€

Video doorstation system 2K Prestige Venus Video Aluminium

APT.	TYPE	CODE	PRICE €	NGV 300	BTU 2K	VT 12	TOTAL €
1	ALSTAR/V-1	45201*	338,00	1	-	1	475,00
2	ALSTAR/V-2	45202*	356,00	1	1	1	541,00
3	ALSTAR/V-3	45203*	374,00	1	1	1	559,00
4	ALSTAR/V-4	45204*	392,00	1	1	1	577,00
5	ALSTAR/V-5	45205*	410,00	1	2	1	643,00
6	ALSTAR/V-6	45206*	428,00	1	2	1	661,00
7	ALSTAR/V-7	45207*	446,00	1	2	1	679,00
8	ALSTAR/V-8	45208*	464,00	1	2	1	697,00
9	ALSTAR/V-9	45209*	482,00	1	3	1	763,00
10	ALSTAR/V-10	45210*	500,00	1	3	1	781,00
11	ALSTAR/V-11	45211*	518,00	1	3	1	799,00
12	ALSTAR/V-12	45212*	536,00	1	3	1	817,00
13	ALSTAR/V-13	45213*	554,00	1	4	1	883,00
14	ALSTAR/V-14	45214*	572,00	1	4	1	901,00
15	ALSTAR/V-15	45215*	590,00	1	4	1	919,00
16	ALSTAR/V-16	45216*	608,00	1	4	1	937,00
17	ALSTAR/V-17	45217*	626,00	1	5	1	1003,00
18	ALSTAR/V-18	45218*	644,00	1	5	1	1021,00
19	ALSTAR/V-19	45219*	662,00	1	5	1	1039,00
20	ALSTAR/V-20	45220*	680,00	1	5	1	1057,00

For additional entrances, select the doorstation of your choice and add a brancher:

	016050	016051	016009
	95,00 €	48,00 €	42,00 €



Prestige Aluminium



APT.	TYPE	CODE	PRICE €	NGV 300	BTU 2K	VT 12	TOTAL €
1	INSTAR/V-1	452015	365,00	1	-	1	502,00
2	INSTAR/V-2	452025	384,00	1	1	1	569,00
3	INSTAR/V-3	452035	403,00	1	1	1	588,00
4	INSTAR/V-4	452045	422,00	1	1	1	607,00
5	INSTAR/V-5	452055	441,00	1	2	1	674,00
6	INSTAR/V-6	452065	460,00	1	2	1	693,00
7	INSTAR/V-7	452075	479,00	1	2	1	712,00
8	INSTAR/V-8	452085	498,00	1	2	1	731,00
9	INSTAR/V-9	452095	517,00	1	3	1	798,00
10	INSTAR/V-10	452105	536,00	1	3	1	817,00
11	INSTAR/V-11	452115	555,00	1	3	1	836,00
12	INSTAR/V-12	452125	574,00	1	3	1	855,00
13	INSTAR/V-13	452135	593,00	1	4	1	922,00
14	INSTAR/V-14	452145	612,00	1	4	1	941,00
15	INSTAR/V-15	452155	631,00	1	4	1	960,00
16	INSTAR/V-16	452165	650,00	1	4	1	979,00
17	INSTAR/V-17	452175	669,00	1	5	1	1046,00
18	INSTAR/V-18	452185	688,00	1	5	1	1065,00
19	INSTAR/V-19	452195	707,00	1	5	1	1084,00
20	INSTAR/V-20	452205	726,00	1	5	1	1103,00

For additional entrances, select the doorstation of your choice and add a brancher:

	016050	016051	016009
	95,00 €	48,00 €	42,00 €

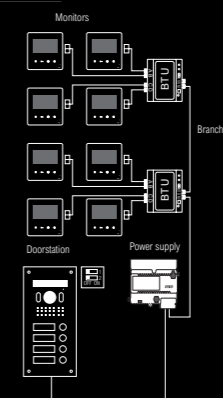

Video doorstation system 2K Prestige Venus Video Stainless Steel

Housing	1-2 Apartments	3-4 Apartments	5-6 Apartments	7 Apartments	8-10 Apartments	11-16 Apartments	17-22 Apartments
AL	62001* - 48,00€	62012* - 60,50€	62003* - 63,00€	62013* - 69,50€	62004* - 76,00€	62023* - 79,80€	62024* - 110,00€

Housing	1-2 Apartments	3-4 Apartments	5-6 Apartments	7 Apartments	8-10 Apartments	11-16 Apartments	17-22 Apartments
IN	620015 - 63,00€	620125 - 68,50€	620035 - 72,00€	620135 - 86,00€	620045 - 91,00€	620235 - 100,00€	620245 - 119,00€



Includes Doorspeaker



Includes Doorspeaker and camera



Includes Doorspeaker and camera

APT.	Doorstation		Doorstation		Doorstation	
	INSTAR/A		INSTAR/V Dome		INSTAR/V	
	2K		2K		2K	
	CODE	PRICE €	CODE	PRICE €	CODE	PRICE €
1	451019	258,50	453019	401,50	452019	401,50
2	451029	279,40	453029	422,40	452029	422,40
3	451039	300,30	453039	443,30	452039	443,30
4	451049	321,20	453049	464,20	452049	464,20
5	451059	342,10	453059	485,10	452059	485,10
6	451069	363,30	453069	506,00	452069	506,00
7	451079	383,90	453079	526,90	452079	526,90
8	451089	404,80	453089	547,80	452089	547,80
9	451099	425,70	453099	568,70	452099	568,70
10	451109	446,60	453109	589,60	452109	589,60
11	451119	467,50	453119	610,50	452119	610,50
12	451129	488,40	453129	631,40	452129	631,40
13	451139	509,30	453139	652,30	452139	652,30
14	451149	530,20	453149	673,20	452149	673,20
15	451159	551,10	453159	694,10	452159	694,10
16	451169	572,00	453169	715,00	452169	715,00
17	451179	592,90	453179	735,90	452179	735,90
18	451189	613,80	453189	756,80	452189	756,80
19	451199	634,70	453199	777,70	452199	777,70
20	451209	655,60	453209	798,60	452209	798,60

Intercom devices Armonia WF 200

Code: 056253 White

Price: 38,00€



- Hands-free device
- Up to 4 parallel devices in the same apartment
- Dimensions 90x157x30mm (W/H/D)

Intercom devices Iris HT 200

Code: 056243 White

Price: 49,00€



- Intercom device with a headset
- Volume adjustment
- Up to 4 parallel devices in the same apartment
- Intercommunication among devices on the same apartment
- Can also function as a bell floor
- Dimensions: 90x220x55mm (W/H/D)

Intercom devices Venus Audio WF 204

Code: 057243 White/ 057240 Black

Price: 99,00€



- Hands-free intercom device
- Safety glass material
- Touch buttons
- Menu
- Intercommunication between the devices
- Up to 4 parallel devices in each call
- Dimensions: 120x180x30mm (W/H/D)

Monitor Orion Vision 4,3" VHS 304

Code: 352243 White / 352240 Black

Price: 169,00€



- Colour TFT monitor 4,3"
- Touch buttons
- High resolution screen 480x480 pixels
- Intercommunication between devices in the same call
- Selection of ringtone volume or mute option
- Functions as a floor bell
- Up to 4 parallel devices in each call
- Dimensions: 136x143x22mm (W/H/D)

Monitor Orion Vision 7" VHS 307

Code: 352273 White / 352270 Black

Price: 209,00€



- Colour TFT monitor 7"
- Touch buttons
- High resolution screen 800x480 pixels
- Intercommunication between devices in the same call
- Selection of ringtone volume or mute option
- Functions as a floor bell
- Up to 4 parallel devices in each call
- Dimensions: 215x152x22mm (W/H/D)

Monitor Orion Vision 7" WiFi VHS 907

Code: 359273 White / 359270 Black

Price: 256,00€



- WiFi connection
- Colour TFT monitor 7"
- Touch buttons
- High resolution screen 800x480 pixels
- Intercommunication between devices in the same call
- Selection of ringtone volume or mute option
- Functions as a floor bell
- Up to 4 parallel devices in each call
- Dimensions: 215x152x22mm (W/H/D)

**Monitor Venus Vision 4,3" VHS 204**

Code: 354243 White / 354240 Black

Price: 242,00€



- Colour TFT monitor 4,3"
- Touch buttons
- English Menu
- High resolution screen 480x480 pixels
- Intercommunication between devices in the same call
- Accepts SD card for photos and video recording
- Selection of different ringtone melodies for each door intercom
- Selection of ringtone volume or mute option
- Functions as a floor bell
- Up to 4 parallel devices in each call
- Dimensions: 158x198x33mm (W/H/D)

Monitor Zeus Vision 7" VHS 207

Code: 354273 White / 354270 Black

Price: 284,00€



- Colour TFT monitor 7"
- Touch buttons
- Safety glass screen
- English Menu
- High resolution display 800x480 pixels
- Intercommunication between devices
- Accepts SD card for photos and video recording
- Selection of different ringtone melodies for each door intercom
- Selection of ringtone volume or mute option
- Functions as a floor bell with its own ringtone
- Up to 4 parallel devices in each call
- Dimensions: 184x186x23mm (W/H/D)

Wired floor bell **Venus Bell**

TYPE	CODE	UNIT PRICE
VHC 700 White	227003	45,00
VHC 700 Black	227000	45,00

TYPE	CODE	UNIT PRICE
VHC 12 White	227123	45,00
VHC 12 Black	227120	45,00

Wired floor buttons **Stainless Steel**

TYPE	CODE	UNIT PRICE
BMO Inox	220001	25,20
BMO Gold	220002	29,40
BMN Inox	230001	25,20
BMN Gold	230002	29,40



Oval style

Wired floor buttons with engraving **Stainless Steel**

TYPE	CODE	UNIT PRICE
BMO Inox	X220001	41,00
BMO Gold	X220002	45,20
BMN Inox	X230001	41,00
BMN Gold	X230002	45,20



Neoclassical style



Camera and Speakerphone Venus/V	
Code	350105
Price	340,00 €



Speakerphone Venus/A	
Code	350106
Price	200,00 €



Camera and Speakerphone Star/V	
Code	350103
Price	300,00 €



Speakerphone Star/A	
Code	350102
Price	170,00 €



Coloured camera CMIR 220 Dome	
Code	350220
Price	180,00 €



Power supply BUS NGV-300	
Code	016050
Price	95,00 €



Power supply KIT BUS NGV-400	
Code	016070
Price	60,00 €



Transformer power supply VT-12	
Code	016009
Price	42,00 €



Video Brancher BTU-2K	
Code	016051
Price	48,00 €



Video Converter BDU-2K	
Code	016058
Price	100,00 €



Electric Lock 6-14V AC/DC	
Code	400024
Price	32,00 €



Expander 4 buttons	
Code	342134
Price	17,50 €



Expander 8 buttons	
Code	342054
Price	19,50 €



Mini Video Brancher BTU-2K	
Code	016065
Price	32,00 €

Video doorstation system
KIT 2K with Orion 4,3" monitor

KIT Colour for 1 apartment 4,3 inch



Code	03411*
Price	325,00 €

KIT Colour for 2 apartments 4,3 inch



Code	03421*
Price	492,00 €

NOTES

- For additional entrances select the doorstation of your choice and a brancher:
- Single call doorstation KALBLV-1 (Code. 567011) 180,00 €
- Two-call doorstation KALBLV-2 (Code. 567021) 192,00 €
- Three-call doorstation KALBLV-3 (Code. 567031) 204,00 €
- Four-call doorstation KALBLV-4 (Code. 567041) 216,00 €
- For the addition of a side construction the following is used: ALPSAR-1 (Code. 623111) 77,70 €
- 2-wire power supply KIT NGV-400 (Code. 016070) 60,00 €
- In case of unwiring a brancher is required BTU 2K (Code. 016051) 48,00 €
- Transformer power supply VT12 (Code. 016009) 42,00 €
- The housing is included in the KIT
- Doorstation dimensions: 112x199x40mm (W/H/D)
- Monitor dimensions: 136x143x22mm (W/H/D)
- Side construction dimensions: 125x213x117mm (W/H/D)

KIT Colour for 3 apartments 4,3 inch



Code	03431*
Price	659,00 €

KIT Colour for 4 apartments 4,3 inch



Code	03441*
Price	829,00 €

NOTES

- For additional entrances select the doorstation of your choice and a brancher:
- Single call doorstation KALBLV-1 (Code. 567011) 180,00 €
- Two-call doorstation KALBLV-2 (Code. 567021) 192,00 €
- Three-call doorstation KALBLV-3 (Code. 567031) 204,00 €
- Four-call doorstation KALBLV-4 (Code. 567041) 216,00 €
- For the addition of a side construction the following is used: ALPSAR-1 (Code. 623111) 77,70 €
- 2-wire power supply KIT NGV-400 (Code. 016070) 60,00 €
- In case of unwiring a brancher is required BTU 2K (Code. 016051) 48,00 €
- Transformer power supply VT12 (Code. 016009) 42,00 €
- The housing is included in the KIT
- Doorstation dimensions: 112x199x40mm (W/H/D)
- Monitor dimensions: 136x143x22mm (W/H/D)
- Side construction dimensions: 125x213x117mm (W/H/D)

INSTALLATION

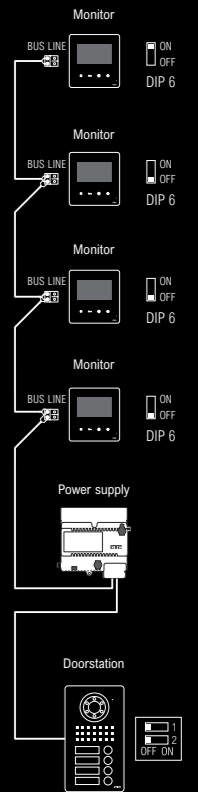

KIT Colour for 1 apartment 7 inch



Code	03711*
Price	389,00 €

KIT Colour for 2 apartments 7 inch



Code	03721*
Price	565,00 €

NOTES

- For additional entrances select the doorstation of your choice and a brancher:
- Single-call doorstation KALBLV-1 (Code. 567011) 180,00 €
- Two-call doorstation KALBLV-2 (Code. 567021) 192,00 €
- Three-call doorstation KALBLV-3 (Code. 567031) 204,00 €
- Four-call doorstation KALBLV-4 (Code. 567041) 216,00 €
- For the addition of a side construction the following is used: ALPSAR-1 (Code. 623111) 77,70 €
- 2-wire power supply KIT NGV-400 (Code. 016070) 60,00 €
- In case of unwiring a brancher is required BTU 2K (Code. 016051) 48,00 €
- Transformer power supply VT12 (Code. 016009) 42,00 €
- The housing is included in the KIT
- Doorstation dimensions: 112x199x40mm (W/H/D)
- Monitor dimensions: 215x152x22mm (W/H/D)
- Side construction dimensions: 125x213x117mm (W/H/D)

KIT Colour for 3 apartments 7 inch



Code	03731*
Price	736,00 €

KIT Colour for 4 apartments 7 inch

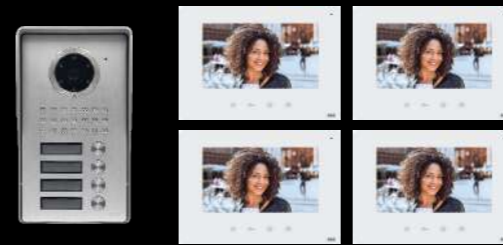

Code	03741*
Price	934,00 €

NOTES

- For additional entrances select the doorstation of your choice and a brancher:
- Single-call doorstation KALBLV-1 (Code. 567011) 180,00 €
- Two-call doorstation KALBLV-2 (Code. 567021) 192,00 €
- Three-call doorstation KALBLV-3 (Code. 567031) 204,00 €
- Four-call doorstation KALBLV-4 (Code. 567041) 216,00 €
- For the addition of a side construction the following is used: ALPSAR-1 (Code. 623111) 77,70 €
- 2-wire power supply KIT NGV-400 (Code. 016070) 60,00 €
- In case of unwiring a brancher is required BTU 2K (Code. 016051) 48,00 €
- Transformer power supply VT12 (Code. 016009) 42,00 €
- The housing is included in the KIT
- Doorstation dimensions: 112x199x40mm (W/H/D)
- Monitor dimensions: 215x152x22mm (W/H/D)
- Side construction dimensions: 125x213x117mm (W/H/D)

INSTALLATION

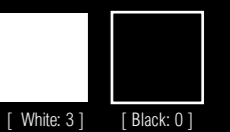
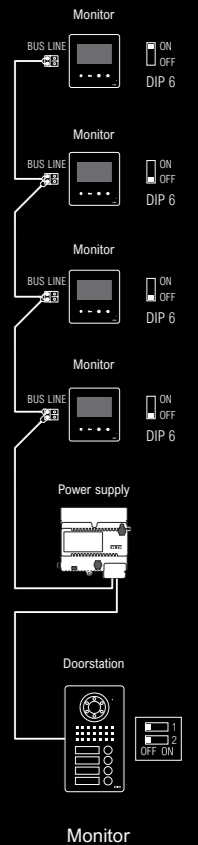

KIT Audio for 1 apartment



Code	036113
Price	161,00 €

KIT Audio for 2 apartments



Code	036213
Price	199,00 €

NOTES

- For additional entrances select the doorstation of your choice and a brancher:
- Single call doorstation KALBLA-1 (Code. 568011) 85,00 €
- Two-call doorstation KALBLA-2 (Code. 568021) 93,00 €
- Three-call doorstation KALBLA-3 (Code. 568031) 101,00 €
- Four-call doorstation KALBLA-4 (Code. 568041) 109,00 €
- For the addition of a side construction the following is used: ALPSAR-1 (Code. 623111) 77,70 €
- 2-wire power supply KIT NGV-400 (Code. 016070) 60,00 €
- Transformer power supply VT12 (Code. 016009) 42,00 €
- The housing is included in the KIT
- Doorstation dimensions: 112x199x40mm (W/H/D)
- Intercom device dimensions: 90x157x30mm (W/H/D)
- Side construction dimensions: 125x213x117mm (W/H/D)

KIT Audio for 3 apartments



Code	036313
Price	236,00 €

KIT Audio for 4 apartments

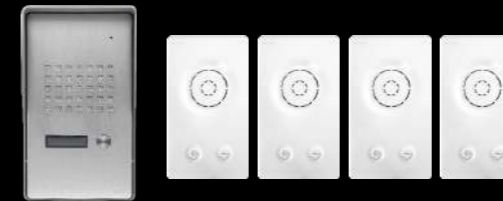

Code	036413
Price	251,00 €

NOTES

- For additional entrances select the doorstation of your choice and a brancher:
- Single call doorstation KALBLA-1 (Code. 568011) 85,00 €
- Two-call doorstation KALBLA-2 (Code. 568021) 93,00 €
- Three-call doorstation KALBLA-3 (Code. 568031) 101,00 €
- Four-call doorstation KALBLA-4 (Code. 568041) 109,00 €
- For the addition of a side construction the following is used: ALPSAR-1 (Code. 623111) 77,70 €
- 2-wire power supply KIT NGV-400 (Code. 016070) 60,00 €
- Transformer power supply VT12 (Code. 016009) 42,00 €
- The housing is included in the KIT
- Doorstation dimensions: 112x199x40mm (W/H/D)
- Intercom device dimensions: 90x157x30mm (W/H/D)
- Side construction dimensions: 125x213x117mm (W/H/D)

INSTALLATION

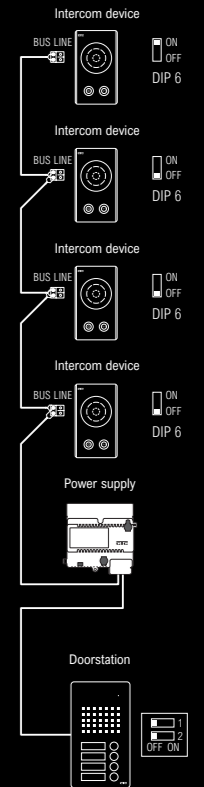

Intercom device



[White: 3]

WiFi KIT DOOR VISION (Non Extendable)

Code: 039113

Price: 319,00€

Doorstation

- Wall-mounting box with waterproofing brim
- Recessed mounting box without waterproofing
- Night vision powered by LED technology
- Power supply with 12V pack attached to monitor

Monitor

- Colour TFT monitor 7"
- WiFi connection
- Touch buttons
- High resolution screen 800x480 pixels
- Wall mounting
- Adjustable volume of the call or mute option
- Functions as a floor bell
- Easy installation on IOS & Android
- P2p cloud support for remote connection
- Wiring system: 4 wires
- Monitor colour: White
- Doorstation colour: Silver
- Doorstation dimensions: 112x199x40mm (W/H/D)
- Monitor dimensions: 215x152x22mm (W/H/D)



Customized constructions

Mailbox
Standard dimensions **Prestige**

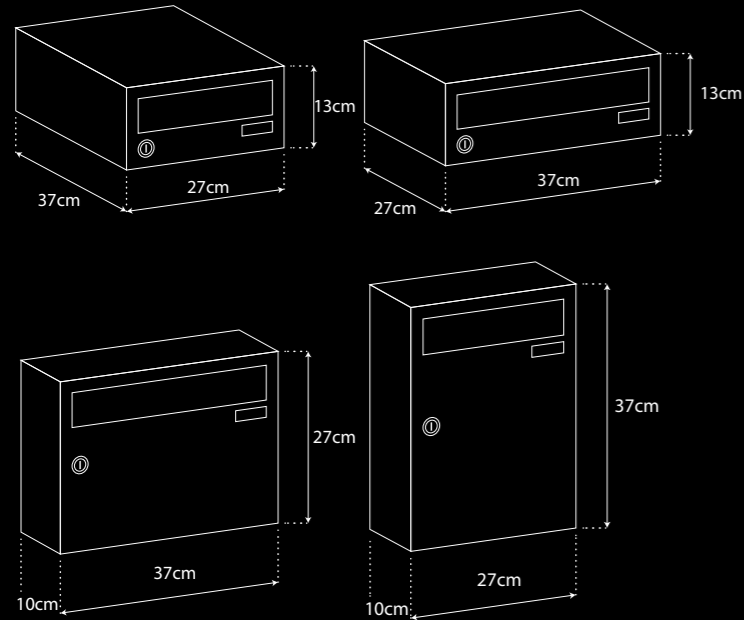

TYPE	CODE	UNIT PRICE
UPBK-1/RAL (recessed)	74801*	116,00
UPBK-1/INOX (recessed)	74801*	165,00
APBK-1/RAL (external)	74701*	140,00
APBK-1/INOX (external)	74701*	175,00

Prestige Aluminium



Prestige Inox

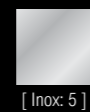

Frame with support
columns for mailboxes



CODE	UNIT PRICE
741000	120,00

Aluminium and Inox sign column

TYPE	CODE	COLOUR	UNIT PRICE
CS-AL	64609*	RAL	880,00
CS-INOX	646095	INOX	1020,00

Dimensions: 32 x 170 x 10cm (W/H/D)

Perforated Illuminated sign 25x15

TYPE	CODE	COLOUR	UNIT PRICE
L-AL RAL	64703*	RAL	86,00
L-INOX	647035	INOX	98,00

Dimensions: 25 x 15cm (W/H)

Sign 25x15

TYPE	CODE	UNIT PRICE
L-PLEXI	647040	55,00
L-DARWIN	647041	25,00

Dimensions: 25 x 15cm (W/H)

Prestige Aluminium



Prestige Inox

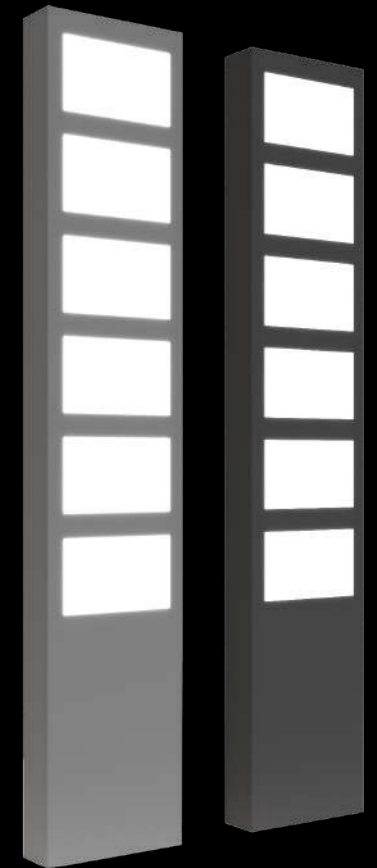

Single Contact Column Prestige
Aluminium and **Stainless Steel**

TYPE	CODE	COLOUR	UNIT PRICE
AFKS/1	64501*	RAL	325,00
SSFKS/1	646015	INOX	570,00

Dimensions: 16 x 170 x 8cm (W/H/D)

Double Contact Column Prestige
Aluminium and **Stainless Steel**

TYPE	CODE	COLOUR	UNIT PRICE
AFKS/2	64502*	RAL	515,00
SSFKS/2	646025	INOX	765,00

Dimensions: 32 x 170 x 10cm (W/H/D)

Prestige Aluminium



Prestige Inox

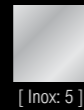

NOTES

For more information and customized constructions contact our company

Engraving without illumination

MATERIAL	CODE	PRICE
AL	647006	39,90
IN	647004	50,40

Engraved Illumination

MATERIAL	CODE	PRICE
AL	647003	179,60
IN	647001	199,90
3D-AL	647020	233,50
3D-IN	647025	260,00

Fingerprint Access

TYPE	CODE	PRICE
FP 200	390112	350,00

Magnetic metal with engraving

TYPE	CODE	PRICE
L-INOX/M	320177	26,90

Base Cover

MATERIAL	CODE	PRICE
AL SMALL	64611*	35,00
AL LARGE	64612*	45,00
IN SMALL	646115	55,00
IN LARGE	646125	65,00

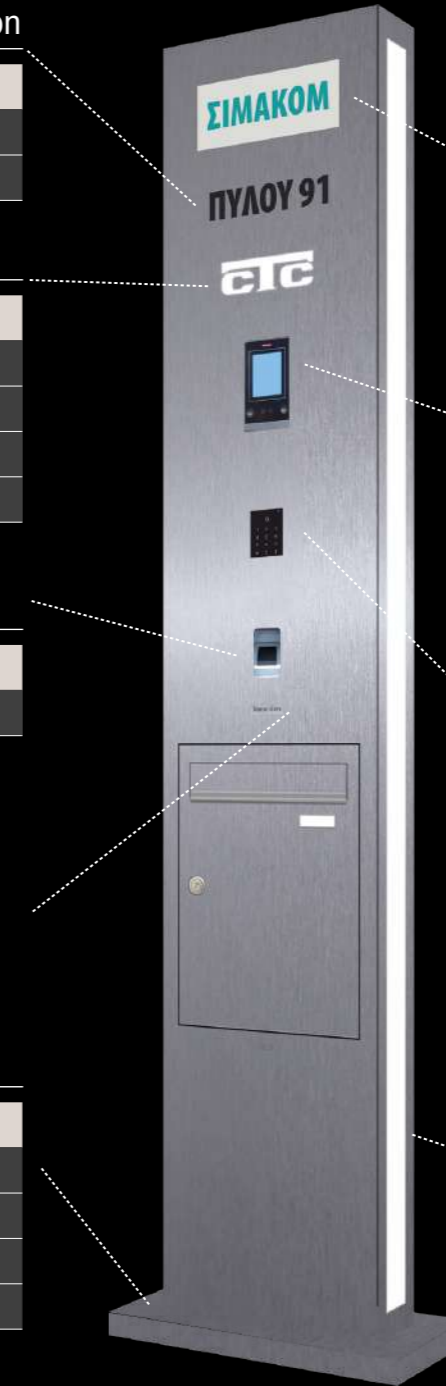

Board Plexi

KIND	CODE	PRICE
WITHOUT LIGHTING	647007	59,90
WITH LIGHTING	647008	85,10

Face Access

TYPE	CODE	PRICE
FACE ID	401403	775,00

Access control with Card Reader

TYPE	CODE	PRICE
TFI	402052	58,00
TFI TUYA	402051	84,00
RFID TAG	017019	2,10
CARD	017011	2,80

Lighting

TYPE	CODE	PRICE
M-LED 1	649001	59,90
M-LED 2	649002	99,90
M-LED 3	649003	149,90

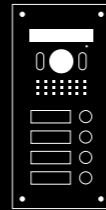
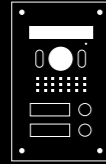

Apartments	1 to 2
Recessed box dimensions	110x190 (WxH)
Front dimensions	130x210 (WxH)

Apartments	3 to 4
Recessed box dimensions	110x250 (WxH)
Front dimensions	130x270 (WxH)

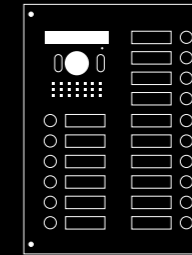
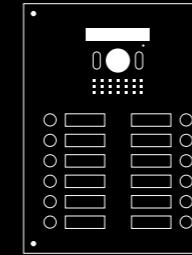

Apartments	11 to 12
Recessed box dimensions	230x310(WxH)
Front dimensions	250x330 (WxH)

Apartments	13 to 16
Recessed box dimensions	230x310 (WxH)
Front dimensions	250x330 (WxH)

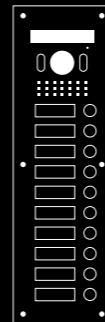
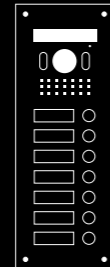
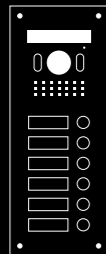

Apartments	5 to 6
Recessed box dimensions	110x310 (WxH)
Front dimensions	130x330 (WxH)

Apartments	7
Recessed box dimensions	110x330 (WxH)
Front dimensions	130x350 (WxH)

Apartments	8 to 10
Recessed box dimensions	110x400 (WxH)
Front dimensions	130x420 (WxH)

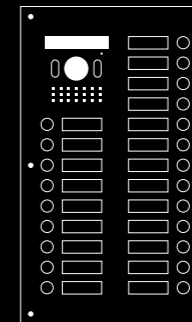
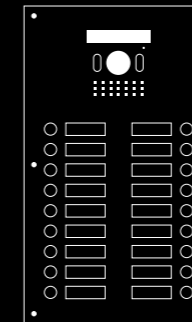

Apartments	17 to 18
Recessed box dimensions	230x400 (WxH)
Front dimensions	250x420 (WxH)

Apartments	19 to 22
Recessed box dimensions	230x400 (WxH)
Front dimensions	250x420 (WxH)

NOTES

- Depth of recessed box: 45mm
- Aluminium front thickness:3mm
- Inox front thickness: 2mm

NOTES

- Depth of recessed box: 45mm
- Aluminium front thickness:3mm
- Inox front thickness: 2mm

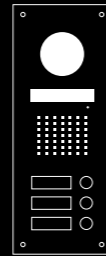
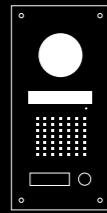

Apartments	1
Recessed box dimensions	110x250 (WxH)
Front dimensions	110x250 (WxH)

Apartments	2 to 3
Recessed box dimensions	110x310 (WxH)
Front dimensions	130x330 (WxH)

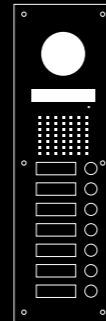
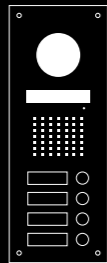

Apartments	4
Recessed box dimensions	110x330 (WxH)
Front dimensions	130x350 (WxH)

Apartments	5 to 7
Recessed box dimensions	110x400 (WxH)
Front dimensions	130x420 (WxH)

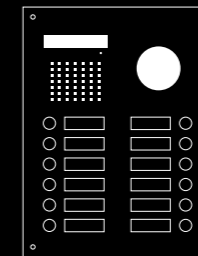

Apartments	8 to 12
Recessed box dimensions	230x310 (WxH)
Front dimensions	250x330 (WxH)

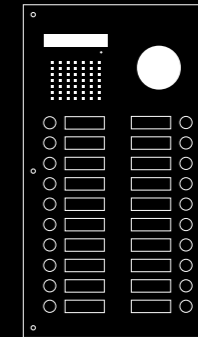
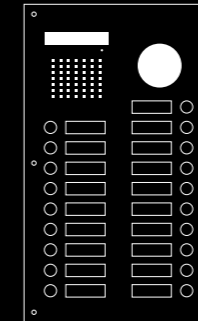

Apartments	13 to 19
Recessed box dimensions	230x400(WxH)
Front dimensions	250x420 (WxH)

Apartments	20
Recessed box dimensions	230x420 (WxH)
Front dimensions	250x440 (WxH)

NOTES

- Depth of recessed box: 45mm
- Aluminium front thickness:3mm
- Inox front thickness: 2mm

NOTES

- Depth of recessed box: 45mm
- Aluminium front thickness:3mm
- Inox front thickness: 2mm

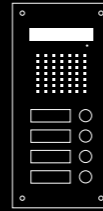
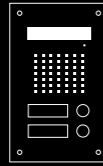

Apartments	1 to 2
Recessed box dimensions	110x190 (WxH)
Front dimensions	130x210 (WxH)

Apartments	3 to 4
Recessed box dimensions	110x250 (WxH)
Front dimensions	130x270 (WxH)

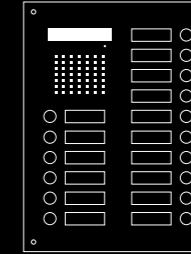
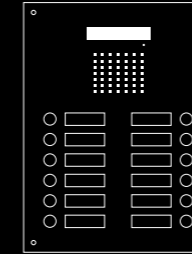

Apartments	11 to 12
Recessed box dimensions	230x310(WxH)
Front dimensions	250x330 (WxH)

Apartments	13 to 16
Recessed box dimensions	230x310 (WxH)
Front dimensions	250x330 (WxH)

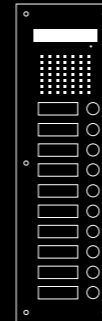
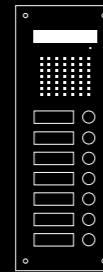
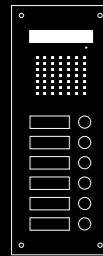

Apartments	5 to 6
Recessed box dimensions	110x310 (WxH)
Front dimensions	130x330 (WxH)

Apartments	7
Recessed box dimensions	110x330 (WxH)
Front dimensions	130x350 (WxH)

Apartments	8 to 10
Recessed box dimensions	110x400 (WxH)
Front dimensions	130x420 (WxH)

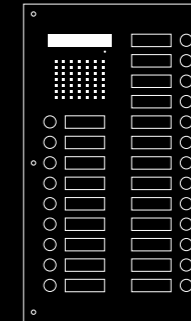
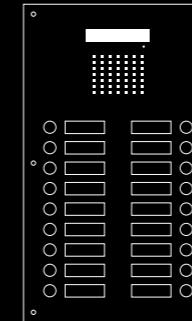

Apartments	17 to 18
Recessed box dimensions	230x400 (WxH)
Front dimensions	250x420 (WxH)

Apartments	19 to 22
Recessed box dimensions	230x400 (WxH)
Front dimensions	250x420 (WxH)

NOTES

- Depth of recessed box: 45mm
- Aluminium front thickness:3mm
- v: 2mm

NOTES

- Depth of recessed box: 45mm
- Aluminium front thickness:3mm
- Inox front thickness: 2mm

CTC Intercom correspondences
with doorphones of other companies

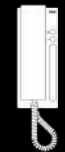

INTERCOM DEVICE HT 501	STR 2003/2	ACET 701	ACET 901	BITRON AN 0002	BPT	BPT A7 72 TB	CITIFONIX	CITVOX	COMELIT OKAY	COMELIT VOX 2000	VIDEX
1	1	7	5	9	2	8	3	5	5	P1	5
T	T	3	1	2	5	6	4	7	2	2	1
M	M	4	2	1	1	4	1	10	3/6	3	6
S	S	5	4	11	3	7	5	T	1	1	3
O	O	6	3	6	4	5 5	2	9	4	4	T



INTERCOM DEVICE HT 501	ELVOX 870	FARFISA PT 510	FERMAX GONDOLA	FERMAX REKTO TF-4	GOLMAR T-600	GOLMAR T-800	GOLMAR T-100A	GOLMAR M-500 T-2800, T-2802	COMELIT OKAY	LT 600	URMET 1130
1	7	5	4	P	1	P1	11	4	5	T	8 9
T	1	2	2	B	2	10	10	10	2	2	1
M	2	1	1	A	1	5	5	5	3/6	1	2
S	6	6	V/5	E	6	0	12	7	1	6	7
O	4/5 3	3	3	C	3	3	3	3	4	3	11



INTERCOM DEVICE HT 501	LT-LEG.630R	LT-LEG.630 WS	PAGANI COMPACT-71	RITTO ELEGANT 40518	SELT I	SELT I SL/254	SIEDLE HT 611-01	SIEMENS	SIEMENS	TESLA DDZ 85	TESLA DDZ 85
1	5	T	A	11	TV	5	1	11	8 7	1	Z
T	1	2	2	15	1	2	11	2	4	6	6
M	6	1	1	12	2	1	2	7	9	2	2
S	3	6	3	14	7	6	7	3	10	4	4
O	T	3	0	13	8	3 7	9 C	14 1	7 8	3	3



INTERCOM DEVICE HT 502	SILVESTRON	COMET MELLODIC SOUND	BITRON 0077 MELLODIC SOUND	TEGUI
D	E	S	C	1E
1	O	R1	9	3
O	1	4	6	2
M	2	3	2	4
T	3	2	1	5

About SIEMENS
use beeper 6V
continuum

C O N T A C T

Our highly qualified staff provides direct and highly competent assistance - that's what sets our service apart.

Our interest and efforts to expand and continuously improve our business activities make CTC a highly reliable company. Our products offer timeless design and superior quality at competitive prices.

Our team is capable of taking on any project, from developing an idea to its implementation.

POSTAL ADDRESS:

91 Pylou & Serron
104 41 Athens

PHONE:

2105120100

EMAIL:

CTC Electronic sales@simacom.gr

SOCIAL MEDIA:

Facebook CTC ELECTRONIC
Instagram @ctcelectronichellas

“There is no harm in repeating
a good thing.”
-Plato

-
- *Prices quoted are catalogue and do not include VAT.
 - *The company is not responsible for any typographical error.
 - *Prices are subject to change without notice.